

产品规格书

PRODUCT SPECIFICATION

LED 驱动电源 (LED DRIVER)

产品名称 /TITEL: UFO 圆形 LED 驱动电源 (LED DRIVER)

产品型号 /MODEL: PX240-260XYZW

版本 /Rev: A0

- 三合一调光
- 拨码调功率
- 12V 辅助源
- 光控

PX240-260XYZW UFO 圆形 LED 驱动电源 (LED DRIVER)

维嘉鑫电源
LED DRIVER



LED DRIVER

PX240-260XYZW



c  [®] us
E520422

FC IP65

产品描述 PRODUCT DESCRIPTION

PX240 系列是 UFO 圆形非隔离恒流调光电源产品，无频闪，专为工矿灯、HB、高棚灯而设计；采用了全新的隔离调光方案，带有隔离辅助电源、拨码调功率、光控功能，灌封导热硅胶以确保散热，具有超高效率，高可靠性，高性价比等优点。

PX240 Series is non-Isolated UFO LED driver with dimming and Flicker free, with Aux output, dial power and optical control function.

产品特性： PRODUCT DESCRIPTION

※ 符合国际通用交流输入范围 108-305V

International universal AC input range 108-305V

※ 具有主动式 PFC 功能，非隔离恒流电源，无频闪，效率高达 95%

With active PFC function, Flicker free, non-Isolated constant current led driver, 95% efficiency

※ 隔离三合一调光 (0-10V, PWM, 电阻)，调光关断无余晖

Isolated dimming of 0-10V, PWM, RES, Dimming off without afterglow

※ 拨码调电流 (改变输出功率) (可选)

Dial code to adjust current (change output power) (Optional)

※ 隔离辅助供电: 12V/0.2A (可选)

Isolated Aux power: 12V/0.2A(Optional)

※ 光控功能 (可选)

light control function (Optional)

※ 保护种类: 短路, 过流, 过压

Protection: Short Circuit, OCP, OVP

※ 雷击 L-N:4KV, L-PE:6KV, N-PE:6KV (线对地仅限驱动, 成品灯具取决于铝基板耐压)

Lightning Surge L-N:4KV, L-PE:6KV, N-PE:6KV (only for LED driver. The withstand voltage of aluminum PCB must be enough)

※ 5 年质保

5 years warranty

PX240-260XYZW UFO 圆形 LED 驱动电源 (LED DRIVER)

产品编码原则 PRODUCT CODING PRINCIPLE

PX	240	-	260	D	R	L	A
产品系列代码 Series code	功率 Power		最大输出电压 Max voltage	调光 Dimming	电阻调功率 Dial power	光控 Optical control	辅助源 Aux power

后缀“XYZW”是可选择的函数如下表 Suffix“XYZW” is selecting function

"XYZW" 分别代表如下字母 "DRLA" "XYZW" stands for the letters "DRLA"	三合一 调光 3 in 1 Dimming	拨码 / 电位器调功率	光控	辅助源
	(后缀 D) Suffix D	(后缀 R) Suffix R	(后缀 L) Suffix L	(后缀 A) Suffix A
空 (Blank)				
D	√			
DR	√	√		
DRL	√	√	√	
DRLA	√	√	√	√

型号列表 MODEL LIST

型号 Model	最大输入功率 Max input power(W)	输出电压范围 Output voltage range(Vdc)	输出电流 Rated current(A)	效率 Typ. Efficiency (Eff)	总谐波失真 (Typ. THD)	功率因数 PF
PX240-260XYZW*	240	180-260	0.82-1.15	95%	15	0.95
	200	180-260	0.7-1.0	95%	15	0.95

*备注 (Remark):

- ① X can be D or blank, D represents models with 0-10V/PWM/resistor 3in1 dimming output DIM+/DIM-, blank represents models without 0-10V/PWM/resistor 3in1 dimming output DIM+/DIM-.
- ② Y can be R or blank, R represents models with power adjust by resistor output BM+/BM-, blank represents models without power adjust by resistor output BM+/BM-.
- ③ Z can be L or blank, L represents models with Optic control output CDS+/CDS-, blank represents models without Optic control output CDS+/CDS-.
- ④ W can be A or blank, A represents models with Aux output, blank represents models without Aux output.

技术特性 TECHNICAL CHARACTERISTICS

总体输入特性 INPUT CHARACTERISTICS					
项目 Item	单位 Unit	最小值 Min	额定值 Rated	最大值 Max	备注 Remark
输入电压 Input Voltage	Vac	108	120-277V	305	输入电压范围 The range of input voltage.
输入频率 Input Frequency	Hz	47-63			

PX240-260XYZW UFO 圆形 LED 驱动电源 (LED DRIVER)

功率因数 Power Factor	/	0.95	0.97		220Vac,50Hz, 满载 /Full load.
	/	0.90			120-277Vac, 70-100% 负载 /Full load.
总谐波失真 Total Harmonic Distortion	/		10	15%	120-220Vac,50/60Hz, 满载 /Full load.
	/		/	20%	120-277Vac, 70-100% 负载 /Full load.

型号: PX240-260XYZW (额定功率: 240W)

输入输出特性 OUTPUT CHARACTERISTICS

项目 Item	单位 Unit	最小值 Min	典型值 Rated	最大值 Max	备注 Remark
最大输入电流 Max Input Current	A			3.1	120Vac, 满载 /Full load.
输出电压范围 Output voltage range	V	180		260	
输出最大空载电压 Max output voltage of no load	V			300	空载 /No load
输出电流范围 Output adjustable current range	A	0.80		1.15	尾缀 R 机型可调电阻调节 / Variable resistance to adjust current range
输出电流精度 Output current precision	/	-5%	/	+5%	满载 /Full load
开机启动时间 Start time	S			1	120Vac, 满载 /Full load
	S			0.5	277Vac, 满载 /Full load
线性调整率 Line regulation		-2%		+2%	满载 /Full load
负载调整率 Load regulation		-3%		+3%	
效率 @120Vac Efficiency	/	91%	93%	/	输出 260Vdc /Full load
效率 @230Vac Efficiency	/	93%	95%	/	输出 260Vdc /Full load
效率 @277Vac Efficiency	/	93%	95%	/	输出 260Vdc /Full load
输出纹波电流 Ripple current(PK-AV)	/	/	10%	15%	满载 /Full load.
电流过冲响应 Overshoot & undershoot Response	/	/	/	10%	输入 /Input:277Vac 输出 /Output: 满载 /Max load
输入浪涌电流 Input Inrush Current	A	/	/	100	277Vac, 冷启动 /Full load cold start.

型号: PX240-260XYZW (额定功率: 200W)

输入输出特性 OUTPUT CHARACTERISTICS					
项目 Item	单位 Unit	最小值 Min	典型值 Rated	最大值 Max	备注 Remark
最大输入电流 Max Input Current	A			2.6	120Vac, 满载 /Full load.
输出电压范围 Output voltage range	V	180		260	
输出最大空载电压 Max output voltage of no load	V			300	空载 /No load
输出电流范围 Output adjustable current range	A	0.7		1.0	尾缀 R 机型可调电阻调节 / Variable resistance to adjust current range
输出电流精度 Output current precision	/	-5%	/	+5%	满载 /Full load
开机启动时间 Start time	S			1	120Vac, 满载 /Full load
	S			0.5	277Vac, 满载 /Full load
线性调整率 Line regulation		-2%		+2%	满载 /Full load
负载调整率 Load regulation		-3%		+3%	
效率 @120Vac Efficiency	/	91%	93%	/	输出 260Vdc /Full load
效率 @230Vac Efficiency	/	93%	95%	/	输出 260Vdc /Full load
效率 @277Vac Efficiency	/	93%	95%	/	输出 260Vdc /Full load
输出纹波电流 Ripple current(PK-AV)	/	/	10%	15%	满载 /Full load.
电流过冲响应 Overshoot & undershoot Response	/	/	/	10%	输入 /Input:277Vac 输出 /Output: 满载 /Max load
输入浪涌电流 Input Inrush Current	A	/	/	100	277Vac, 冷启动 /Full load cold start.

备注 (Remark):

※ 所有性能参数均在温度 25°C 情况下所量测的典型值, 特别注明除外。

All technical parameters are rated under the condition of 25°C, in addition to special note.

※ 纹波电流以 LED 负载为准。

Ripple current subject to LED load.

PX240-260XYZW UFO 圆形 LED 驱动电源 (LED DRIVER)

其他特性 OTHER CHARACTERISTICS

项目 Item	最小值 Min	典型值 Rated	最大值 Max	备注 Remark	
辅助供电功能 Aux power supply (可选 /Optional)	12V 输出电压范围 /12V output voltage range	10V	12.5V	15V	
	12V 最大输出电流 /12V output current range	/	/	0.2A	
0-10V 调光功能 /dimming function(可选 / Optional)	外加电压 /Applied voltage	0V		12V	
	调光输出范围 /Dimming output range	10%		100%	@loset
	推荐调光电压 /Recommended dimming voltage	0V		10V	DIM+/DIM- 禁止反接
	DIM+ 提供电流 /DIM+ supply current		110uA		
PWM 调光功能 / dimming function (可选 /Optional)	PWM 高电平 /PWM high voltage	9.8V		10.2V	
	PWM 低电平 /PWM low voltage	0V		0.3V	
	PWM 频率段 /PWM frequency	1KHz		2KHz	DIM+/DIM- 禁止反接
	PWM 占空比 /PWM duty	0		100%	
电阻调光功能 / Resistance dimming function (可选 / Optional)	外接电阻值 /Dimming resistance	0K		100K	
	电阻调光范围 /Dimming range	10%		100%	@loset
	DIM+ 提供电流 /DIM+ supply current		110uA		
寿命时间 /Life time	50,000 Hours			Tc ≤ 75°C	
质量保证 /Warranty	5Year			Tc ≤ 75°C	
净重 /Net weight	890g				

备注 (Remark):

※ 以上均在温度 25°C 情况下所量测的典型值，特别注明除外。

All specifications are typical at 25°C unless otherwise stated.

※ 驱动电源作为灯具系统的一个部件，需要最终配合灯具确认 EMI

EMI performance of a luminaire that contains it depends also on the other devices connected to the driver and on the fixture itself.

PX240-260XYZW UFO 圆形 LED 驱动电源 (LED DRIVER)

光控功能(可选) LIGHT CONTROL FUNCTION(Optional)

项目 Item	测试条件 Test Conditions
■光控 (Light Control Function)	当光线低于 40Lx 时, 电源启动; 当光线大于 120Lx 时, 电源关闭 The driver will start-up when brightness less than 40Lx and will close when more than 120Lx.

绝缘性能 ISOLATION FUNCTION

项目 Item	测试方法 Test Method	测试条件 Test Conditions
绝缘耐压 Dielectric strength	输入 - 主输出 Input To Output	/
绝缘耐压 Dielectric strength	输入 - 大地 Input To PE	1600Vac 1 分钟 /minute. 漏电流 Leakage current $\leq 5\text{mA}$
绝缘耐压 Dielectric strength	输入 - 调光线 Input To Dim	1600Vac 1 分钟 /minute. 漏电流 Leakage current $\leq 5\text{mA}$
绝缘阻抗 Isolation Impedance	输入 - 主输出 Input To Output	/
接地电阻 Grounding resistance		$\leq 0.1\Omega @ 25\text{A}, 1\text{min}$

防水等级 WATERPROOF GRADE

IP65 ■ IP66 □ IP67 □ IP68 □ IP00 □ (裸板)

安规要求 SAFETY REQUIREMENT

电源符合以下国际安规标准

The led driver shall be certified under the following international regulatory standards:

Approval	Country	Certified Stats	Standard	Option
CCC	China/ 中国	MEET	GB 19510	■
CE	Europe/ 欧洲	MEET	EN 61347	■
FCC	America/ 美国	MEET	PART 15	■
UL	America/ 美国	MEET	UL8750	■
CUL	Canada/ 加拿大	MEET	UL8750	■

环境要求 ENVIRONMENT REQUIREMENT

项目 Item	单位 Unit	最小值 Min	典型值 Rated	最大值 Max	备注 Remark
工作温度 Tc Temperature	°C	-40	25	90	Tc 为外壳温度 Temperature of Case
储存温度 Storage Temperature	°C	-40	25	80	
相对湿度 Humidity	RH	20%-90% RH non-condensing			工作湿度 Operation Humidity
		20%-90% RH non-condensing			储存湿度 Storage Humidity
冷却方式 Cooling Mode	空气自然冷却 Air Cooling				

PX240-260XYZW UFO 圆形 LED 驱动电源 (LED DRIVER)

可靠性 RELIABILITY

- 电源老化 /BURN-IN TEST

电源在输入 120 和 277Vac(60Hz), 输出满载, 温度 40°C ±5°C条件下, 各老化 4 小时测试。

Input voltage applied to the led driver with 120 and 277 Vac(60Hz),Output full load; 40°C ±5°C environment; Burn-in-test 4 hours respectively.

特性曲线 CHARACTERISTIC CURVE

- 输出功率 VS. 调光信号 /Output power VS. dimming signal

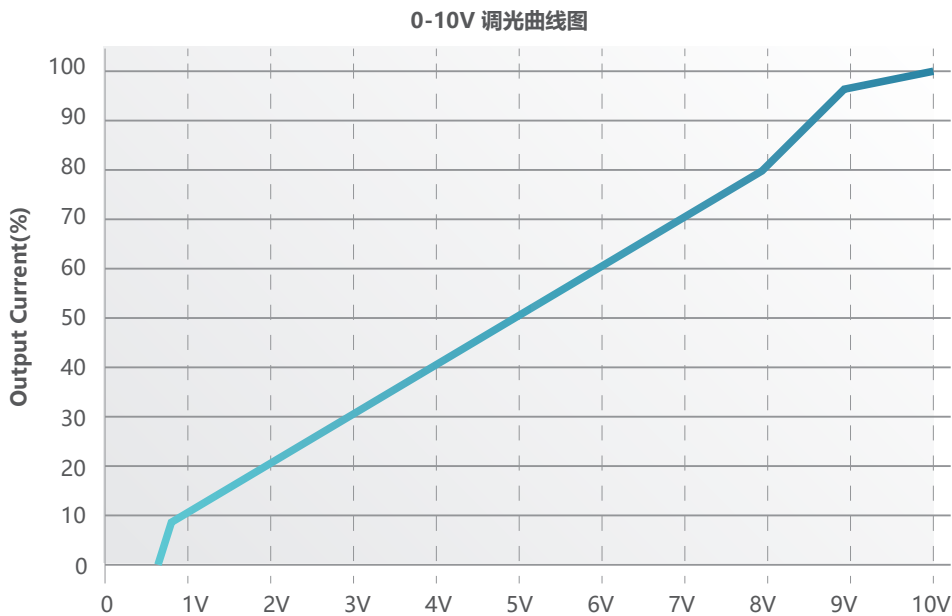

电源寿命曲线 Life curve

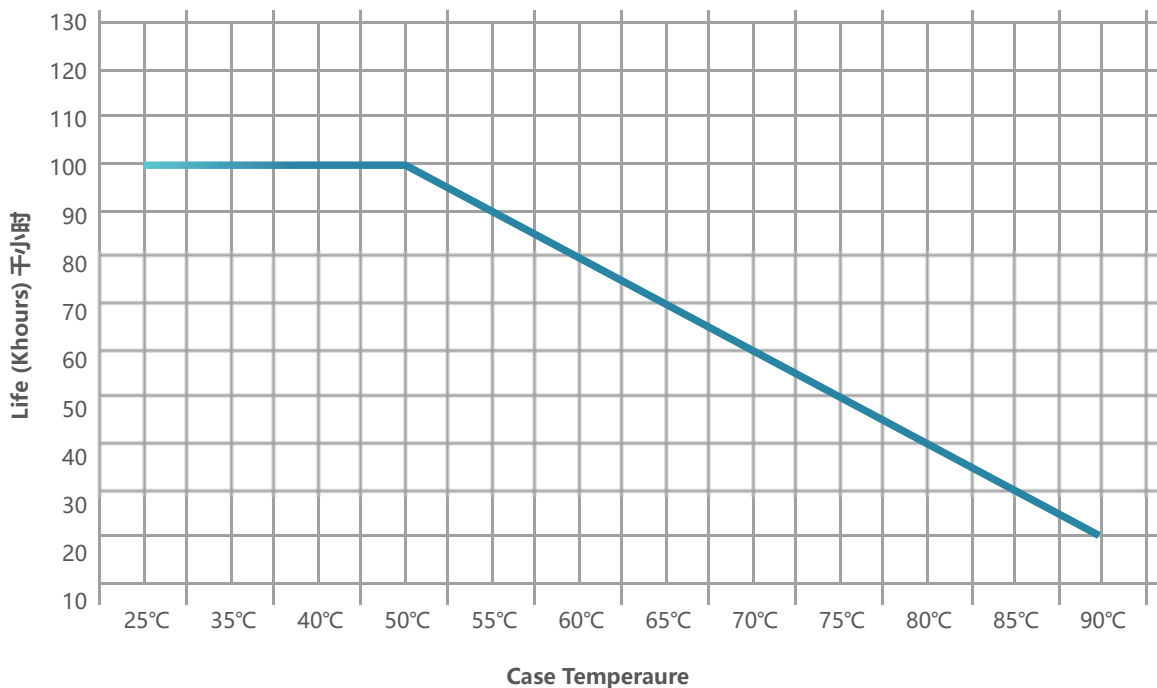

PX240-260XYZW UFO 圆形 LED 驱动电源 (LED DRIVER)

结构尺寸图 Structure size chart

名称 Item	外壳直径	安装直径	安装孔直径	外壳高度	吊环孔径
代号 marking	D	A	4-B	H	R
mm(In.)	143(5.63)	132(5.20)	6.4(0.25)	60(2.36)	M10*1.5 Depth 20mm

名称 Item	吊环固定孔	U 型支架安装孔	U 型支架固定孔	Tc 点位置	Tc 点位置
代号 marking	F	U	UF	X	Y
mm(In.)	M4 screw through hole	M6*1.0 Depth 10mm	M4*0.5 Depth 8mm	5.0(0.2)	30(1.18)

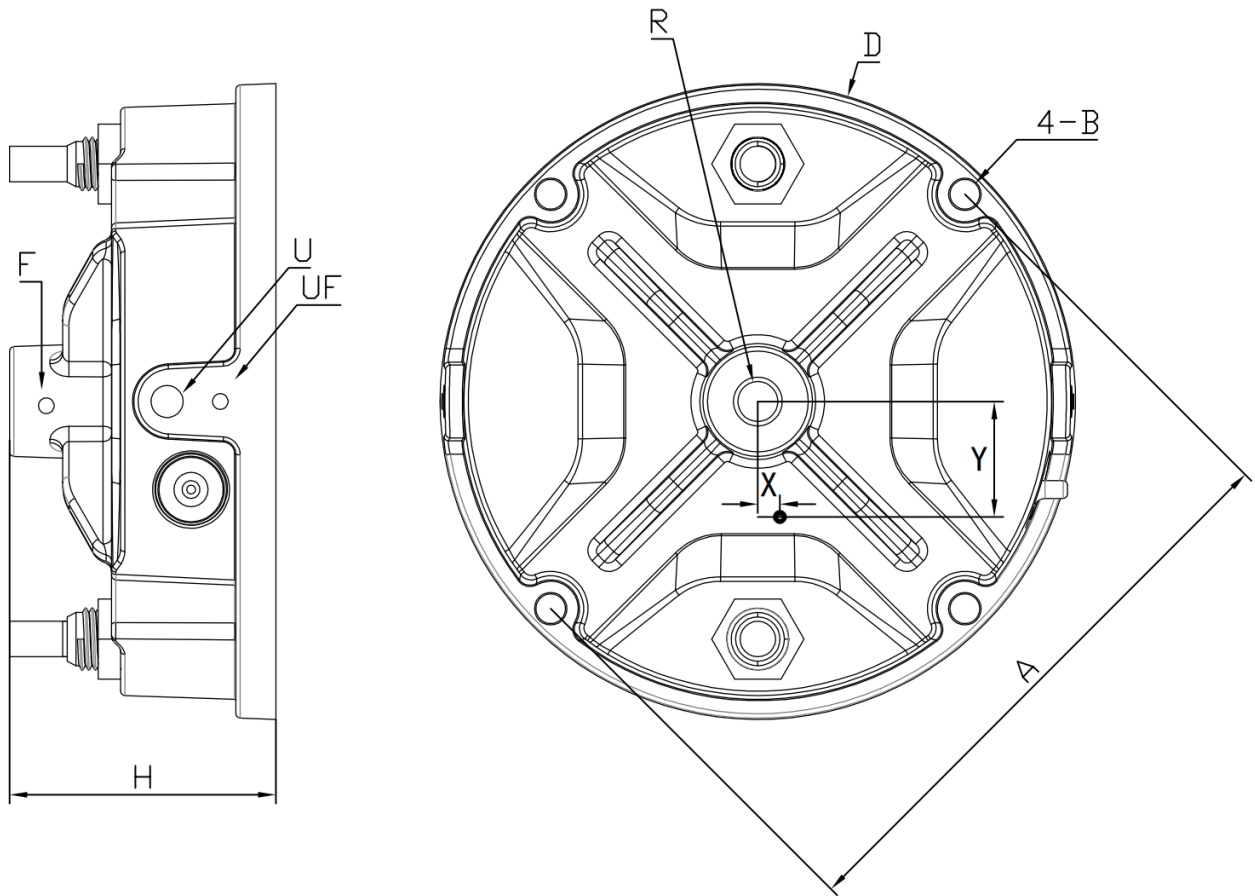

PX240-260XYZW UFO 圆形 LED 驱动电源 (LED DRIVER)

输入 / 输出引线 INPUT AND OUTPUT LEAD WIRE

- 美规标准 (America standard) :

AC 输入 (AC Input) :

AC-L AC-N PE : 黑色 (Black) , 白色 (White) , 绿色 (Green) 3*18AWG SJTW
Length=300±10mm , 电缆剥皮 40mm, 浸锡 10mm





DC 输出 (DC Output) :

Vo+ Vo- : 红色 (Red), 黑色 (Black) 2*18AWG SJTW
Length=300±10mm 电缆剥皮 40mm, 浸锡 10mm

调光 + 辅助源输出 (Dimming+Aux. Output) :

DIM+ DIM- & AUX- AUX+ : 紫色 (Purple) , 粉色 (Pink) , 黑色 & 白色 30% (Black & White 30%)
3*22AWG UL21996
Length=300±10mm 电缆剥皮 40mm, 浸锡 10mm

电源标签 Label

		LED DRIVER	
INPUT	MODEL:PX240-260DRLA	OUTPUT	
ta:60°C tc:90°C	INPUT:120-277V ~ Max.3.1A	RED:LED+ ○	
○ ACL---BLACK	50/60Hz PF ≥0.95 Max.240W	BLACK:LED- ○	
⊕ GREEN	OUTPUT:180-260V = 0.8-1.15A	(OPTIONAL) 12V AUX.	
○ ACN---WHITE		BLACK&WHITE:12V+ ○	
			
E520422	RoHS IP65	PURPLE:DIM+ ○	
Vega Xin Technology Co., Ltd. Of Shenzhen		PINK:DIM-/12V- ○	
		MADE IN CHINA	
		www.cblight.com	

PX240-260XYZW UFO 圆形 LED 驱动电源 (LED DRIVER)

注意事项 Attention

当调光线或者辅助源输出线不使用时，请将电线头用绝缘套管密封，以免影响电源正常工作。
When the dimming wire or Aux output wire is not in use, please seal the end of the wire.

包装 Packing

- 包装箱的外形尺寸为 (单位: mm) : 长 × 宽 × 高 = 470 × 375 × 182
The size of the package is (mm) : L × W × H = 470 × 375 × 182
- 每箱产品的包装数量为 18 台
The number of packages per box of products is 18 sets
- 单机净重: 0.89kg; 整箱毛重: 17kg
Net weight : 0.89 kg; gross weight of whole case: 17kg
- 包装箱上有产品名称、型号、厂家标识、数量、制造日期等
The packing box has the product name, model, factory marking, quantity, date, and so on.

运输 Transportation

适用于车、船、飞机运输，运输中应遮蓬、防晒、文明装卸
Suitable for car, ship, aircraft transport, transport should be awning, civilized loading and unloading.

储存 Store

产品贮存应符合 GB 3873 - 83 的规定
The storage of products shall conform to the regulations of GB 3873-83.

贮存期限超过 1 年的产品要重新检验，合格后方可使用。
Products Storage period exceeding 1 year shall be re-inspected and qualified before use.

RoHS

产品符合欧洲指令 2011/65/EC
Products comply with European directive 2011/65/EC.